

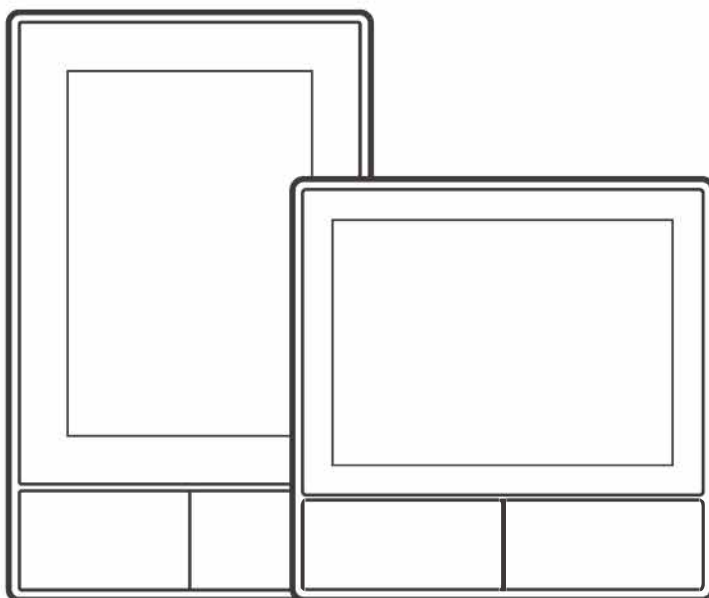

User manual V1.1



NSPanel-US

NSPanel-EU

SONOFF NSPanel Smart Scene Wall Switch

Product Introduction

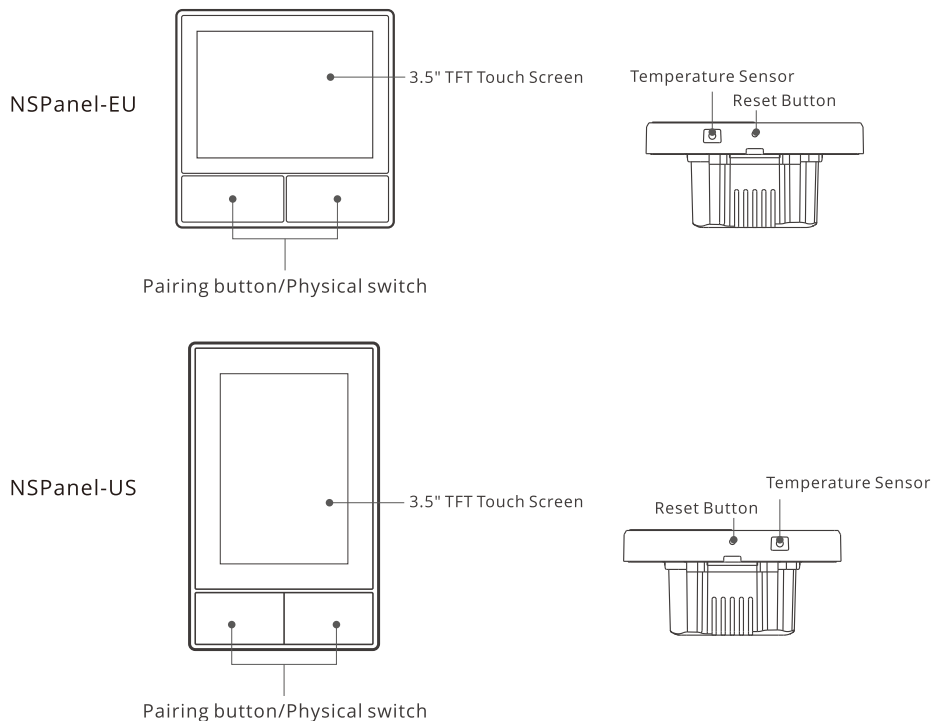

⚠ The device weight is less than 1 kg. The installation height of less than 2 m is recommended.

Features

NSPanel is a dual-channel smart touch control panel integrating three interactive methods, screen touching, voice control and App control. Users can control the device types including smart switch and plugs (heating/cooling) under the eWeLink account. Users are able to control multiple smart devices through adding widgets on their smart phones, such as turn on/off, schedule on/off the connected devices and share them with families to control.



Remote Control



Single/Countdown
Timing



Voice Control



Share Control



3.5" TFT Touch Screen



Adding Widgets



Smart Scene



Thermostat



Inching Mode



Interlock



Group Control



LAN Control

Operating Instruction

1. Power off

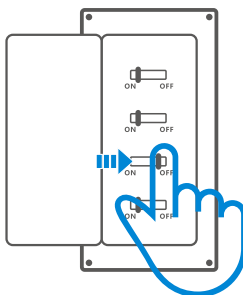

⚠ Please install and maintain the device by a professional electrician. To avoid electric shock hazard, do not operate any connection or contact the terminal connector while the device is powered on!

2. Wiring instruction

Light fixture wiring instruction:

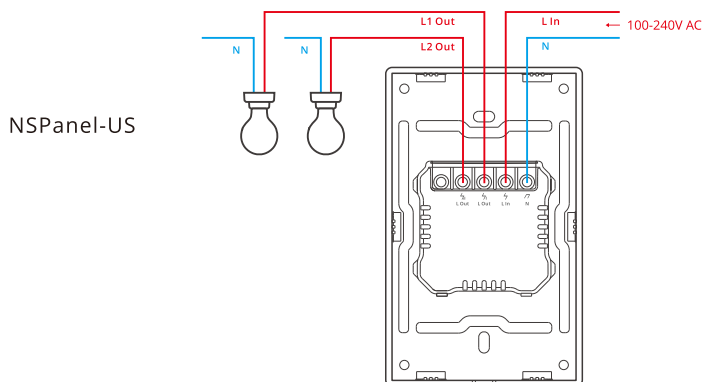
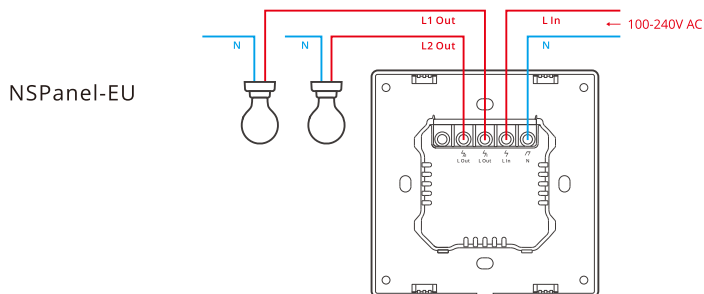

⚠ Make sure all wires are connected correctly.

3. Download the eWeLink App

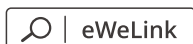

Android™ & iOS

4. Power on

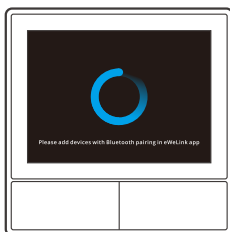

After powering on, the device will enter the bluetooth pairing mode during the first use. The screen status is shown in the above image.

5. Add the device

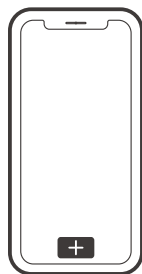

>

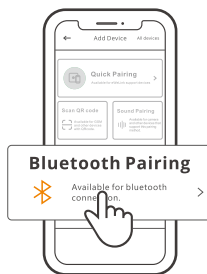

Tap “+” and select “bluetooth pairing”, then operate following the prompt on the App.

Operation Guide

Drop down

Settings of the screen brightness and sleep time

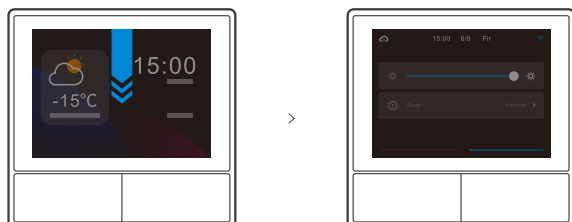

Swipe right

After adding temperature controller function in the App, you can set the added temperature controller on the device.

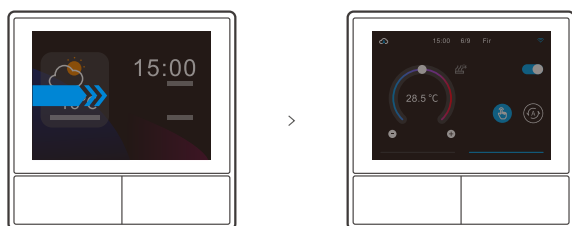

Swipe left

After adding widgets in the App, you can control the added widgets on the device.

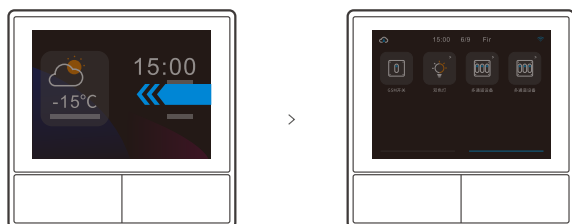

Bind Temperature Control Device

There is a built-in temperature sensor in the NSPanel to monitor the room temperature and you can maintain the room temperature by controlling the cooler/heater, which is connected with smart switches or smart plus and these devices are required to pair with eWeLink App.

Access the NSPanel interface in the App and tap “Thermostat” to select the devices in the Action device list. All the listed devices are supported to bind with the Thermostat (including two NSPanel channels). You can only select one device or one channel of the multi-channel device to execute and then choose heater or cooler as the Device type.

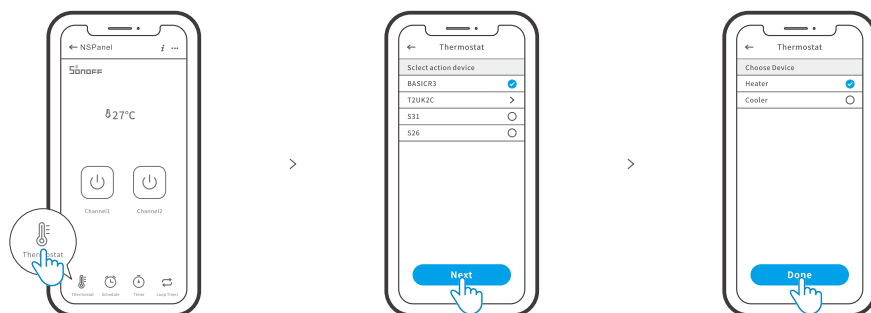

Active the Thermostat after selecting the Action device and Device type, then you can see there are two modes to control the temperature which are Manual mode and Auto mode.

Manual mode:

Allow you to adjust the temperature manually whenever you want and then the Thermostat will execute to maintain the manual setting temperature.

Auto mode:

Allow you to set 6 target temperature at most by tapping “Add” to set the temperature respectively. Once set, all setting will execute automatically at certain time duration and cannot be controlled manually unless switched to the Manual mode. The binding devices will turn off when they are out of schedule.

⚠ Actual room temperature will be $\pm 1^{\circ}\text{C}$. For example, the setting temperature is 26°C but the actual temperature range is between 25°C and 27°C .

Add Widgets

NSPanel can be added 8 widgets in the screen for Quick Control. The form of widget can be single device, group devices of the congeneric devices and Tap to Perform Scene. In addition, you can control more features of the multi-gang and lighting devices in the secondary interface.

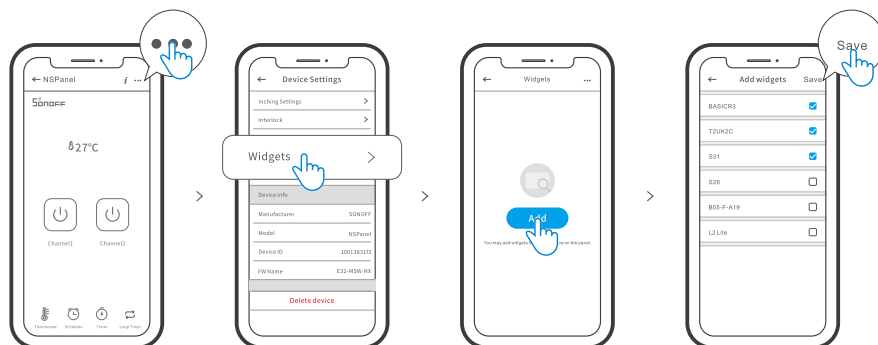

Specifications

Model	NSPanel-EU, NSPanel-US
Input	100-240V ~ 50/60Hz 4A Max
Output	100-240V ~ 50/60Hz 2A/Gang 4A/Total
LED load	150W/110V/Gang, 300W/110V/Total 300W/220V/Gang, 600W/220V/Total
Wi-Fi	IEEE 802.11 b/g/n 2.4GHz
Bluetooth Standard	4.2 BLE
Screen Size	3.5" (Capacitive Touch Panel)
Screen Resolution	480*320px
Operating systems	Android & iOS
Shell materials	PC V0+CRS+Toughened Glass
Dimension	NSPanel-EU: 86x86x41.7mm NSPanel-US: 120x74x41.7mm

Re-establish Pairing of the NSPanel

When you want to change the NSPanel's account or connected WIFI, it requires you to pair the NSPanel again. Press any bottom of the device for 5s until the screen indicates that it had entered into Bluetooth pairing mode and then release. Now the NSPanel is available for Bluetooth pairing in the eWeLink App.

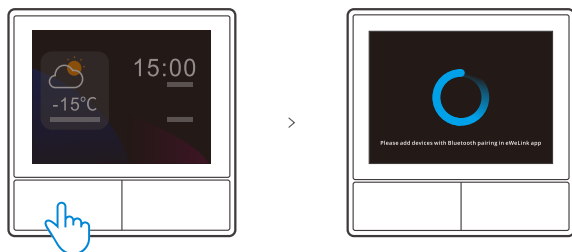

⚠ The device will exit the bluetooth pairing mode if not paired within 3mins.

Factory Reset

Deleting the device on the eWeLink app indicates you restore it to factory setting.

Common Problems

Fail to pair Wi-Fi devices to eWeLink App

1. Make sure the device is in pairing mode. After three minutes of unsuccessful pairing, the device will automatically exit pairing mode.
2. Please turn on location services and allow location permission. Before choosing the Wi-Fi network, location services should be turned on and location permission should be allowed. Location information permission is used to obtain Wi-Fi list information. If you click Disable, you will not be able to add devices.
3. Make sure your Wi-Fi network runs on the 2.4GHz band.
4. Make sure you entered a correct Wi-Fi SSID and password, no special characters contained. Wrong password is a very common reason for pairing failure.
5. The device shall get close to the router for a good transmission signal condition while pairing.

FCC Warning

Changes or modifications not expressly approved by the party responsible for compliance could avoid the user's authority to operate the equipment.

This device complies with part 15 of the FCC Rules. Operation is subject to the following two conditions: (1) This device may not cause harmful interference, and (2) this device must accept any interference received, including interference that may cause undesired operation.

FCC Radiation Exposure Statement:

This equipment complies with FCC radiation exposure limits set forth for an uncontrolled environment. This equipment should be installed and operated with minimum distance 20cm between the radiator & your body. This transmitter must not be co-located or operating in conjunction with any other antenna or transmitter.

Note:

This equipment has been tested and found to comply with the limits for a Class B digital device, pursuant to part 15 of the FCC Rules. These limits are designed to provide reasonable protection against harmful interference in a residential installation. This equipment generates, uses and can radiate radio frequency energy and, if not installed and used in accordance with the instructions, may cause harmful interference to radio communications. However, there is no guarantee that interference will not occur in a particular installation. If this equipment does cause harmful interference to radio or television reception, which can be determined by turning the equipment off and on, the user is encouraged to try to correct the interference by one or more of the following measures:

- Reorient or relocate the receiving antenna.
- Increase the separation between the equipment and receiver.
- Connect the equipment into an outlet on a circuit different from that to which the receiver is connected.
- Consult the dealer or an experienced radio/TV technician for help.

Hereby, Shenzhen Sonoff Technologies Co., Ltd. declares that the radio equipment type NSPanel-EU, NSPanel-US is in compliance with Directive 2014/53/EU. The full text of the EU declaration of conformity is available at the following internet address:

<https://sonoff.tech/usermanuals>



Shenzhen Sonoff Technologies Co., Ltd.

1001, BLDG8, Lianhua Industrial Park, shenzhen, GD, China
ZIP code: 518000 Website: sonoff.tech

